

SK 9 DGD 065 ET

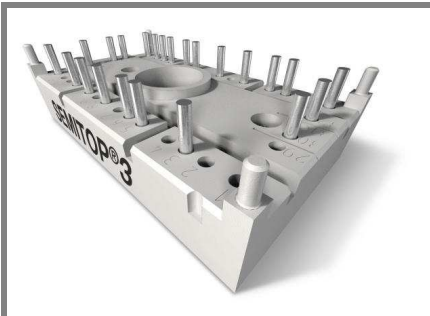

SEMITOP® 3

**3-phase bridge rectifier +
3-phase bridge inverter**

SK 9 DGD 065 ET

Preliminary Data

Features

- Compact design
- One screw mounting
- Heat transfer and isolation through direct copper bonded aluminum oxide ceramic (DCB)
- Ultrafast NPT technology IGBT
- CAL Technology FWD
- Integrated NTC temperature sensor

Typical Applications*

- Inverter

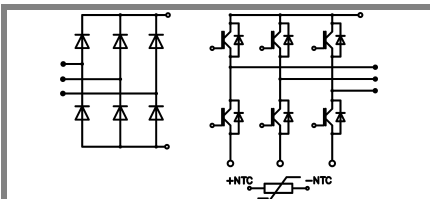

DGD - ET

Absolute Maximum Ratings		$T_s = 25^\circ\text{C}$, unless otherwise specified	
Symbol	Conditions	Values	Units
IGBT - Inverter			
V_{CES}		600	V
I_C	$T_s = 25 (80)^\circ\text{C}$	12 (8)	A
I_{CRM}	$I_{CRM} = 2 \times I_{Cnom}$, $t_p = 1 \text{ ms}$	12	A
V_{GES}		± 20	V
T_j		-40 ... +150	$^\circ\text{C}$
Diode - Inverter			
I_F	$T_s = 25 (80)^\circ\text{C}$	20 (13)	A
I_{FRM}	$I_{FRM} = 2 \times I_{Fnom}$, $t_p = 1 \text{ ms}$	16	A
T_j		-40 ... +150	$^\circ\text{C}$
Rectifier			
V_{RRM}		800	V
I_F	$T_s = 80^\circ\text{C}$	25	A
I_{FSM} / I_{TSM}	$t_p = 10 \text{ ms}$, $\sin 180^\circ$, $T_j = 25^\circ\text{C}$	220	A
I_t^2	$t_p = 10 \text{ ms}$, $\sin 180^\circ$, $T_j = 25^\circ\text{C}$	240	A^2s
T_j		-40 ... +150	$^\circ\text{C}$
T_{sol}	Terminals, 10s	260	$^\circ\text{C}$
T_{stg}		-40 ... +125	$^\circ\text{C}$
V_{isol}	AC, 1 min. / 1s	2500 / 3000	V

Characteristics		$T_s = 25^\circ\text{C}$, unless otherwise specified			
Symbol	Conditions	min.	typ.	max.	Units
IGBT - Inverter					
V_{CEsat}	$I_C = 6 \text{ A}$, $T_j = 25 (125)^\circ\text{C}$		2 (2,2)		V
$V_{GE(th)}$	$V_{GE} = V_{CE}$, $I_C = 0,5 \text{ mA}$	3	4	5	V
$V_{CE(TO)}$	$T_j = 25^\circ\text{C} (125)^\circ\text{C}$		1,2 (1,1)		V
r_T	$T_j = 25^\circ\text{C} (125)^\circ\text{C}$		133 (183)		m Ω
C_{ies}	$V_{CE} = V_{GE} = 0 \text{ V}$, $f = 1 \text{ MHz}$		0,35		nF
C_{oes}	$V_{CE} = V_{GE} = 0 \text{ V}$, $f = 1 \text{ MHz}$		0,4		nF
C_{res}	$V_{CE} = V_{GE} = 0 \text{ V}$, $f = 1 \text{ MHz}$		0,25		nF
$R_{th(j-s)}$	per IGBT			2,6	K/W
$t_{d(on)}$	under following conditions		20		ns
t_r	$V_{CC} = 300 \text{ V}$, $V_{GE} = \pm 15 \text{ V}$		25		ns
$t_{d(off)}$	$I_C = 6 \text{ A}$, $T_j = 125^\circ\text{C}$		145		ns
t_f	$R_{Gon} = R_{Goff} = 120 \Omega$		25		ns
E_{on}	inductive load		0,22		mJ
E_{off}			0,12		mJ
Diode - Inverter					
$V_F = V_{EC}$	$I_F = 8 \text{ A}$, $T_j = 25(125)^\circ\text{C}$		1,35		V
$V_{(TO)}$	$T_j = 25^\circ\text{C} (125)^\circ\text{C}$		(0,8)		V
r_T	$T_j = 25^\circ\text{C} (125)^\circ\text{C}$		(44)		m Ω
$R_{th(j-s)}$	per diode			2,7	K/W
I_{RRM}	under following conditions		4,2		A
Q_{rr}	$I_F = 8 \text{ A}$, $V_R = 300 \text{ V}$		0,65		μC
E_{rr}	$V_{GE} = 0 \text{ V}$, $T_j = 125^\circ\text{C}$ $di_{F/dt} = -120 \text{ A}/\mu\text{s}$				mJ
Diode rectifier					
V_F	$I_F = 20 \text{ A}$, $T_j = 25()^\circ\text{C}$		1,1		V
$V_{(TO)}$	$T_j = 150^\circ\text{C}$		0,85		V
r_T	$T_j = 150^\circ\text{C}$		15		m Ω
$R_{th(j-s)}$	per diode			2,15	K/W
Temperatur sensor					
R_{ts}	5 %, $T_r = 25 (100)^\circ\text{C}$		5000(493)		Ω
Mechanical data					
w			31		g
M_s	Mounting torque	2,3		2,5	Nm

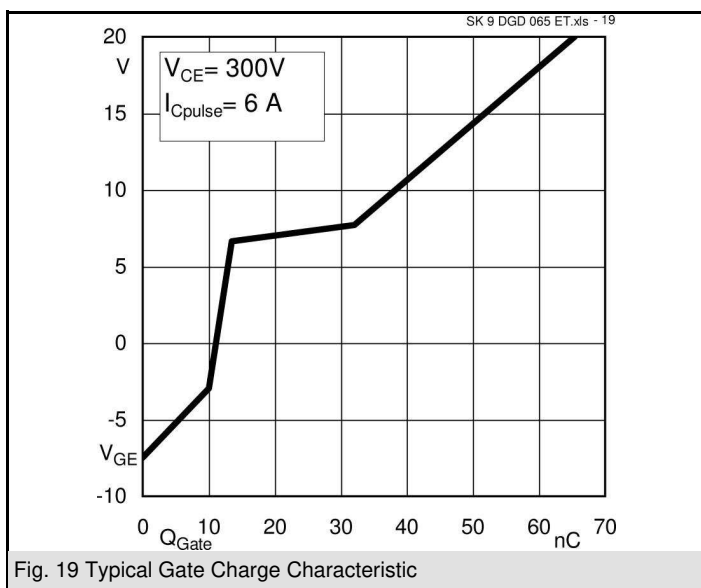
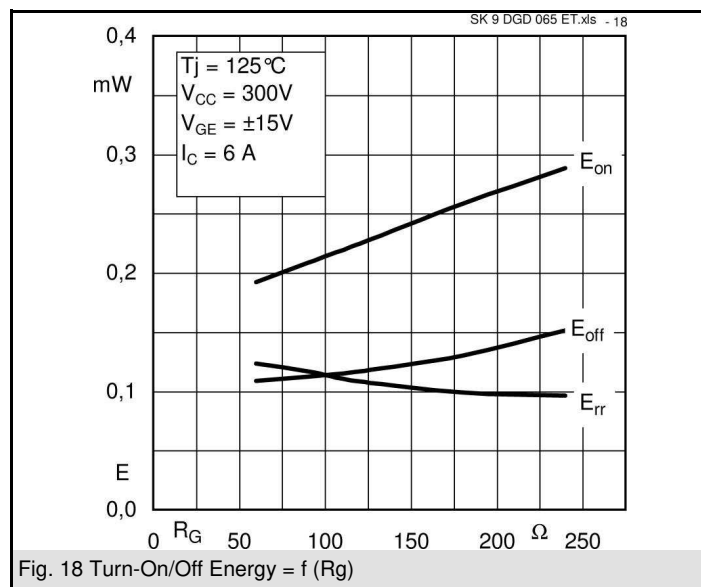
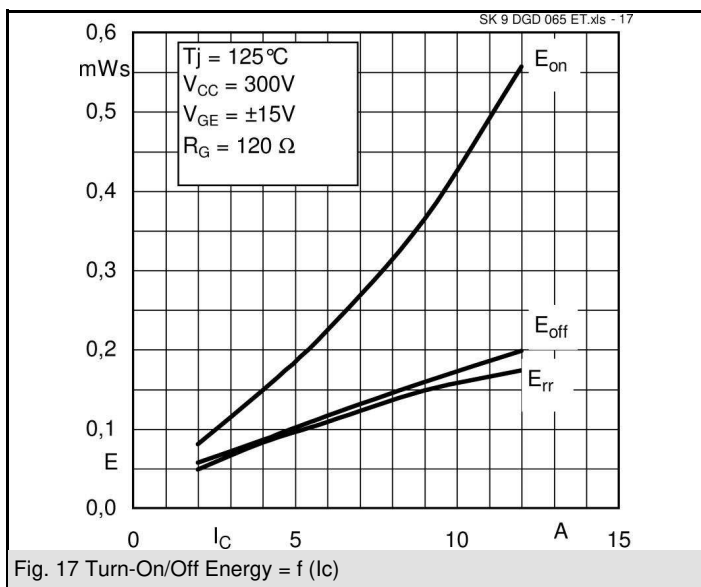
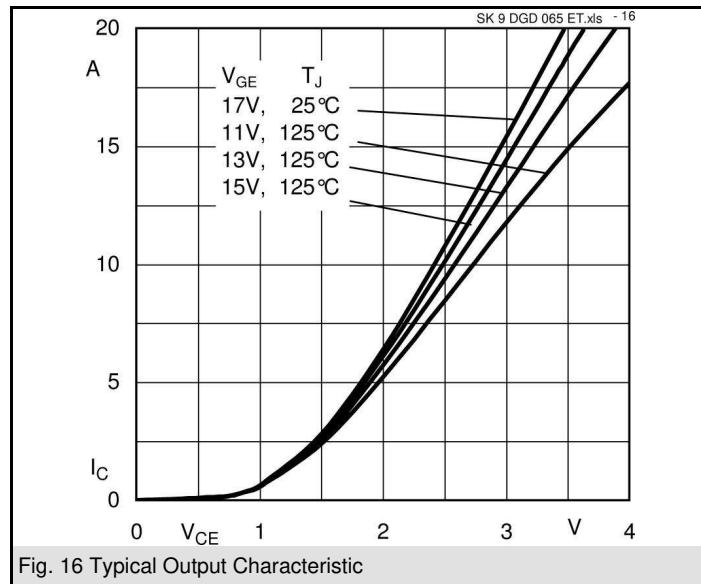
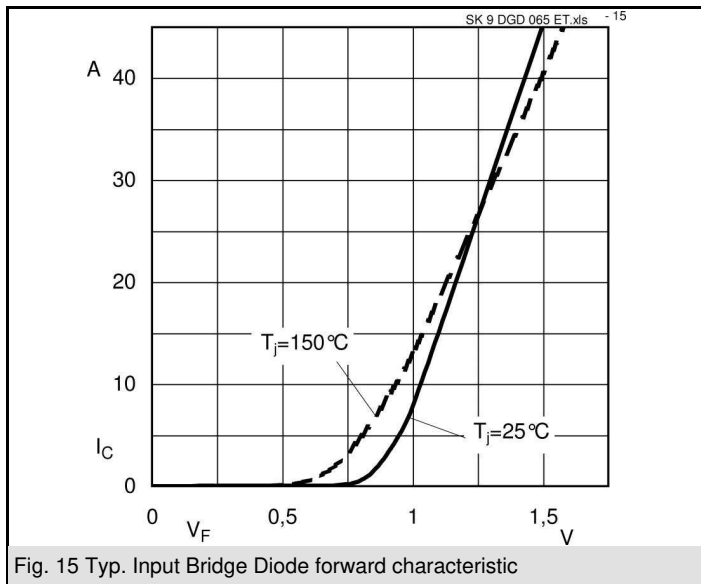

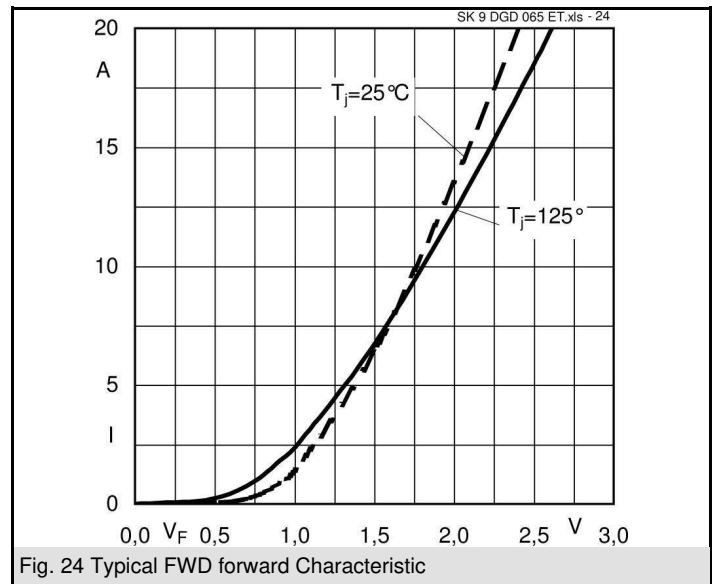
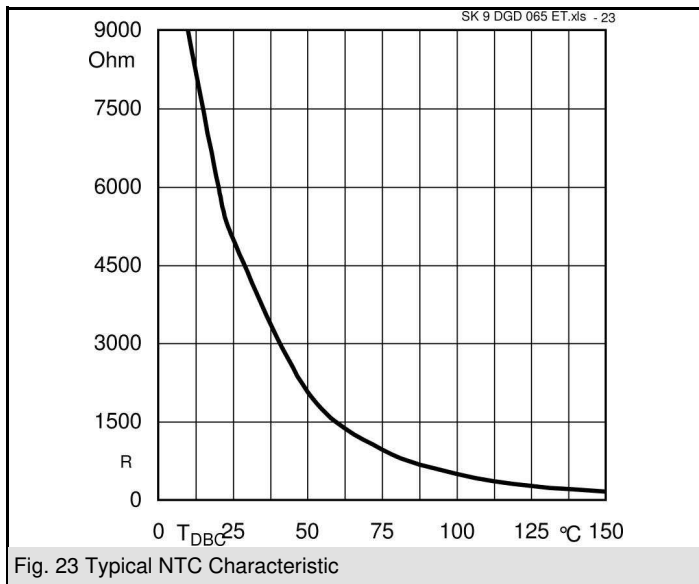
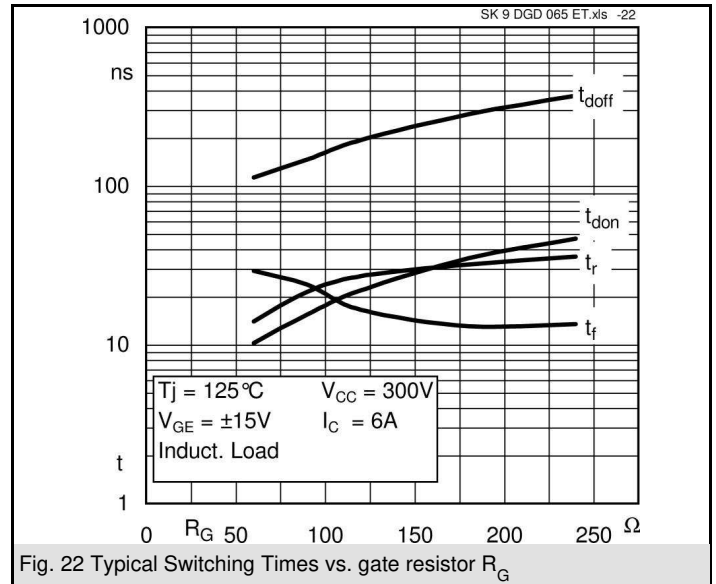
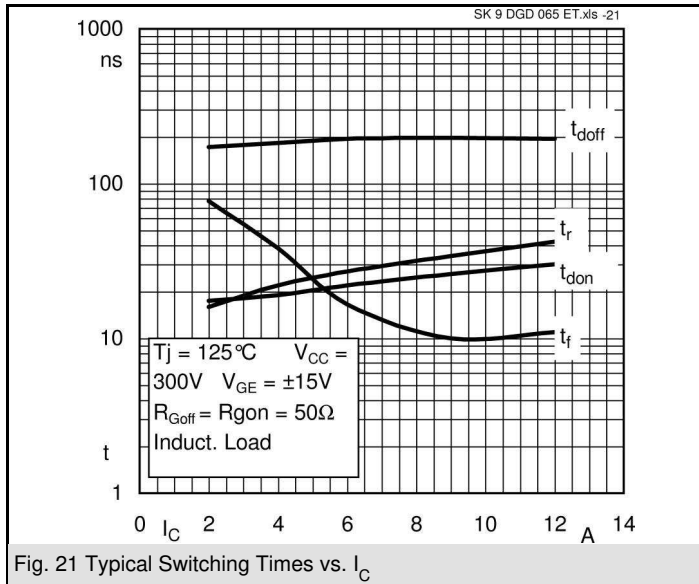

SK 9 DGD 065 ET

Dimensions in mm

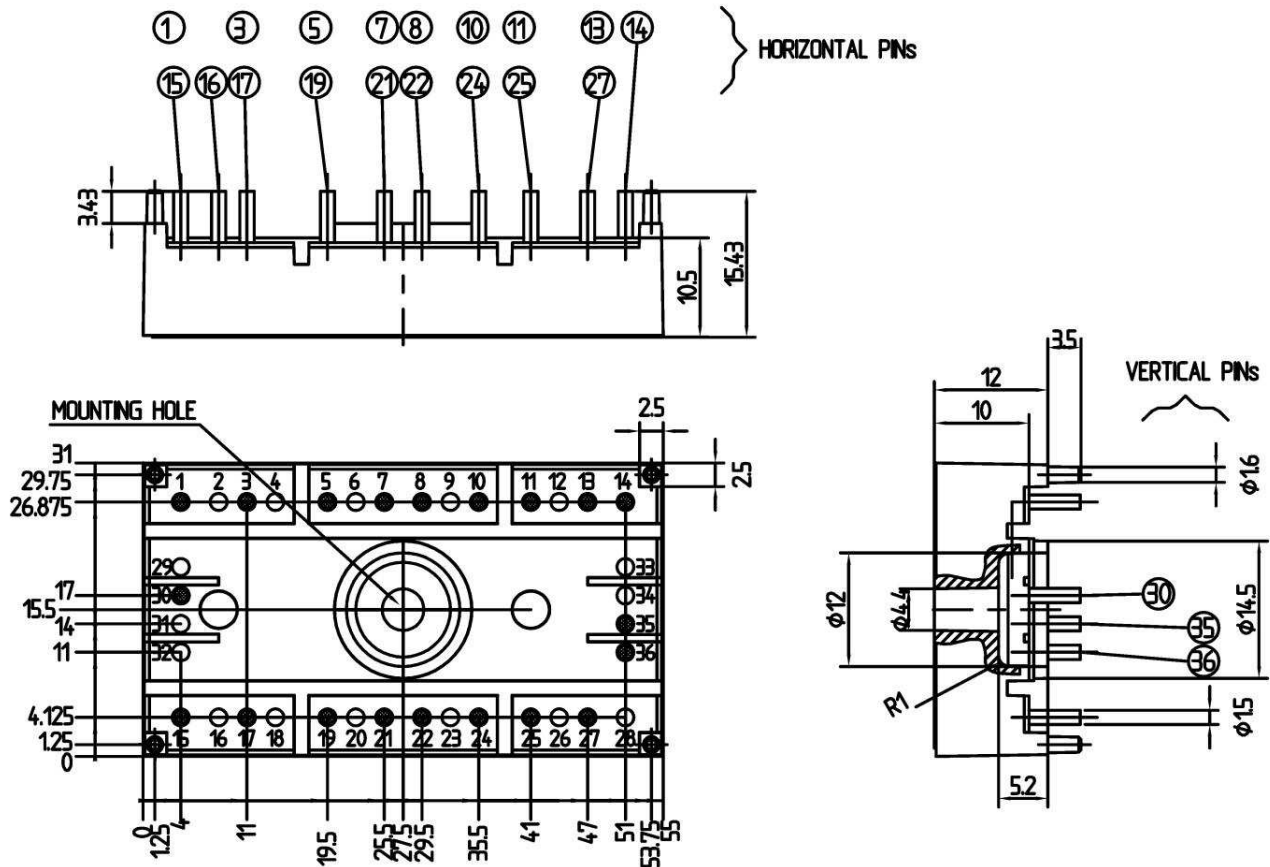

Case T60 (Suggested hole diameter, in the PCB, for solder pins and plastic mounting pins: 2mm)

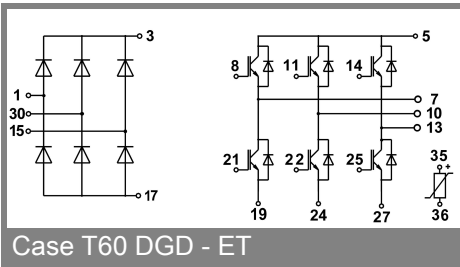

Case T60 DGD - ET

This is an electrostatic discharge sensitive device (ESDS), international standard IEC 60747-1, Chapter IX.

* The specifications of our components may not be considered as an assurance of component characteristics. Components have to be tested for the respective application. Adjustments may be necessary. The use of SEMIKRON products in life support appliances and systems is subject to prior specification and written approval by SEMIKRON. We therefore strongly recommend prior consultation of our personal.