

SKiiP 1814 GB17E4-3DUW V2

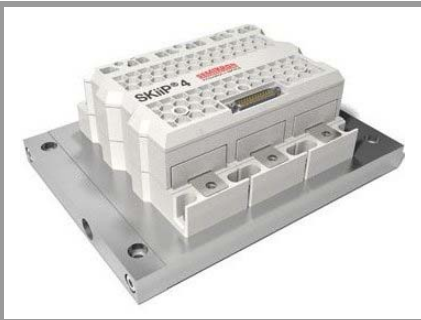

SKiiP® 4

2-pack-integrated intelligent Power System

SKiiP 1814 GB17E4-3DUW V2

Features

- Intelligent Power Module
- Integrated current and temperature measurement
- Integrated DC-link measurement
- Solder free power section
- IGBT4 and CAL4F technology
- Safety isolated switching and sensor signals
- Digital signal transmission
- CAN Interface
- 100% tested IPM
- RoHS compliant
- UL file no. E242581

Typical Applications*

- Renewable energies
- Traction
- Elevators
- Industrial drives

Remarks

For further information please refer to SKiiP@4 Technical Explanation

Footnotes

¹⁾With assembly of suitable MKP capacitor per terminal

²⁾The specified maximum operation junction temperature T_{vjop} can be $> 150^{\circ}\text{C}$ for a max. of 1000cum. Operations hours

Absolute Maximum Ratings						
Symbol	Conditions		Values	Unit		
System						
$V_{CC}^{1)}$	Operating DC link voltage		1300	V		
V_{isol}	DC, $t = 1 \text{ s}$, each polarity		5600	V		
$I_{t(RMS)}$	per AC terminal, rms, sinusoidal current		500	A		
$I_{max (peak)}$	max. peak current of power section		2700	A		
I_{FSM}	$T_j = 175^{\circ}\text{C}$, $t_p = 10 \text{ ms}$, sin 180°		11907	A		
I^2t	$T_j = 175^{\circ}\text{C}$, $t_p = 10 \text{ ms}$, diode		709	kA^2s		
f_{out}	fundamental output frequency (sinusoidal)		1	kHz		
T_{stg}	storage temperature		-40 ... 85	$^{\circ}\text{C}$		
IGBT						
V_{CES}	$T_j = 25^{\circ}\text{C}$		1700	V		
I_C	$T_j = 175^{\circ}\text{C}$	$T_s = 25^{\circ}\text{C}$	2547	A		
		$T_s = 70^{\circ}\text{C}$	2049	A		
I_{Cnom}			1800	A		
$T_j^{2)}$	junction temperature		-40 ... 175	$^{\circ}\text{C}$		
Diode						
V_{RRM}	$T_j = 25^{\circ}\text{C}$		1700	V		
I_F	$T_j = 175^{\circ}\text{C}$	$T_s = 25^{\circ}\text{C}$	1771	A		
		$T_s = 70^{\circ}\text{C}$	1401	A		
I_{Fnom}			1800	A		
$T_j^{2)}$	junction temperature		-40 ... 175	$^{\circ}\text{C}$		
Driver						
V_s	power supply		19.2 ... 28.8	V		
V_{iH}	input signal voltage (high)		$V_s + 0.3$	V		
dv/dt	secondary to primary side		75	$\text{kV}/\mu\text{s}$		
f_{sw}	switching frequency		15	kHz		
Characteristics						
Symbol	Conditions		min.	typ.	max.	Unit
IGBT						
$V_{CE(sat)}$	$I_C = 1800 \text{ A}$ at terminal	$T_j = 25^{\circ}\text{C}$	2.12	2.43	V	
		$T_j = 150^{\circ}\text{C}$	2.53	2.79	V	
V_{CE0}		$T_j = 25^{\circ}\text{C}$	1.10	1.20	V	
		$T_j = 150^{\circ}\text{C}$	1.00	1.10	V	
r_{CE}	at terminal	$T_j = 25^{\circ}\text{C}$	0.57	0.69	$\text{m}\Omega$	
		$T_j = 150^{\circ}\text{C}$	0.85	0.94	$\text{m}\Omega$	
$E_{on} + E_{off}$	$I_C = 1800 \text{ A}$ $T_j = 150^{\circ}\text{C}$	$V_{CC} = 900 \text{ V}$	1335		mJ	
		$V_{CC} = 1300 \text{ V}$	2130		mJ	
$R_{th(j-s)}$	per IGBT switch			0.0183	K/W	
$R_{th(j-r)}$	per IGBT switch			0.0132	K/W	

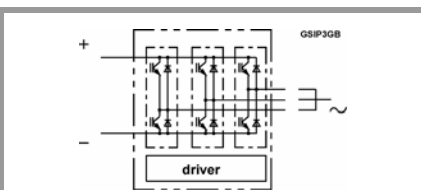

GB

SKiiP 1814 GB17E4-3DUW V2

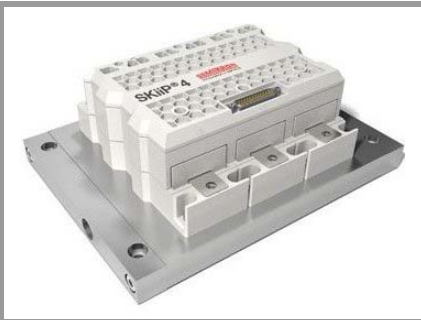

SKiiP® 4

2-pack-integrated intelligent Power System

SKiiP 1814 GB17E4-3DUW V2

Features

- Intelligent Power Module
- Integrated current and temperature measurement
- Integrated DC-link measurement
- Solder free power section
- IGBT4 and CAL4F technology
- Safety isolated switching and sensor signals
- Digital signal transmission
- CAN Interface
- 100% tested IPM
- RoHS compliant
- UL file no. E242581

Typical Applications*

- Renewable energies
- Traction
- Elevators
- Industrial drives

Remarks

For further information please refer to SKiiP®4 Technical Explanation

Footnotes

- ¹⁾With assembly of suitable MKP capacitor per terminal
- ²⁾The specified maximum operation junction temperature T_{vjop} can be $> 150^{\circ}\text{C}$ for a max. of 1000cum. Operations hours

Characteristics						
Symbol	Conditions		min.	typ.	max.	Unit
Diode						
$V_F = V_{EC}$	$I_F = 1800\text{ A}$ at terminal	$T_j = 25^{\circ}\text{C}$		2.02	2.34	V
		$T_j = 150^{\circ}\text{C}$		2.27	2.62	V
V_{F0}		$T_j = 25^{\circ}\text{C}$		1.21	1.36	V
		$T_j = 150^{\circ}\text{C}$		0.99	1.12	V
r_F	at terminal	$T_j = 25^{\circ}\text{C}$		0.45	0.55	m Ω
		$T_j = 150^{\circ}\text{C}$		0.71	0.84	m Ω
E_{rr}	$I_F = 1800\text{ A}$ $T_j = 150^{\circ}\text{C}$	$V_R = 900\text{ V}$		309		mJ
		$V_R = 1300\text{ V}$		498		mJ
$R_{th(j-s)}$	per diode switch				0.0375	K/W
$R_{th(j-r)}$	per diode switch				0.0331	K/W
Driver						
V_s	supply voltage non stabilized		19.2	24	28.8	V
I_{SO}	bias current @ $V_s = 24\text{V}$, $f_{sw} = 0$, $I_{AC} = 0$			230		mA
I_S	$k_1 = 42\text{ mA/kHz}$, $k_2 = 0.001\text{ mA/A}^2$, $f_{out} = 50\text{Hz}$, sinusoidal current		= 230	$+ k_1 * f_{sw} + k_2 * I_{AC}^2$		mA
V_{IT+}	input threshold voltage (HIGH)		$0,7 * V_s$			V
V_{IT-}	Input threshold voltage (LOW)			$0,3 * V_s$		V
R_{IN}	input resistance			13		k Ω
C_{IN}	input capacitance			1		nF
t_{pRESET}	error memory reset time			500		ms
$t_{pReset(OCP)}$	Over current reset time, FRT-function can be activated via CAN interface					μs
t_{TD}	top / bottom switch interlock time			3		μs
t_{jitter}	jitter clock time			50	58	ns
t_{SIS}	short pulse suppression time			0.6		μs
t_{POR}	Power-On-Reset completed				1	s
$I_{digiout}$	digital output sink current (HALT-signal)				16	mA
$V_{it+ HALT}$	input threshold voltage HIGH HALT (Low -->High)		$0,6 * V_s$			V
$V_{it- HALT}$	input threshold voltage LOW HALT (High --> Low)			$0.4 * V_s$		V
$t_{d(terr)}$	Error delay time (from detection to HALT), (depends on kind of error)		3		370	μs
I_{TRIPSC}	over current trip level		2700			A_{PEAK}
I_{LL}				n.a.		A_{PEAK}
T_{trip}	over temperature trip level		128	135	142	$^{\circ}\text{C}$
$T_{DriverTrip}$	over temperature PCB trip level		113	120	124	$^{\circ}\text{C}$
V_{DCtrip}	over voltage trip level,		1300	1340	1380	V
$V_{DCtripLL}$				n.a.		V

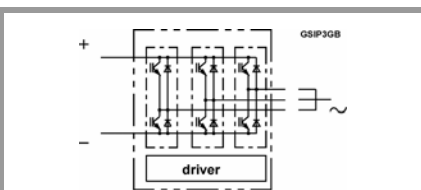

GB

SKiiP 1814 GB17E4-3DUW V2



SKiiP® 4

2-pack-integrated intelligent Power System

SKiiP 1814 GB17E4-3DUW V2

Features

- Intelligent Power Module
- Integrated current and temperature measurement
- Integrated DC-link measurement
- Solder free power section
- IGBT4 and CAL4F technology
- Safety isolated switching and sensor signals
- Digital signal transmission
- CAN Interface
- 100% tested IPM
- RoHS compliant
- UL file no. E242581

Typical Applications*

- Renewable energies
- Traction
- Elevators
- Industrial drives

Remarks

For further information please refer to SKiiP®4 Technical Explanation

Footnotes

¹⁾With assembly of suitable MKP capacitor per terminal

²⁾The specified maximum operation junction temperature T_{vjop} can be $> 150^{\circ}\text{C}$ for a max. of 1000cum. Operations hours

Characteristics						
Symbol	Conditions		min.	typ.	max.	Unit
System						
$t_{d(on)IO}$	$V_{CC} = 1300\text{ V}$ $I_C = 1800\text{ A}$	turn on propagation delay time		2.8		μs
$t_{d(off)IO}$	$T_j = 25^{\circ}\text{C}$	turn off propagation delay time		2.6		μs
dV_{CE}/dt_{on}	$T_j = 25^{\circ}\text{C}$ $V_{CC} = 1300\text{ V}$	$I_C = 0\text{ A}$		9		$\text{kV}/\mu\text{s}$
		$I_C = 1800\text{ A}$		2		$\text{kV}/\mu\text{s}$
dV_{CE}/dt_{off}		$I_C = 1800\text{ A}$		9		$\text{kV}/\mu\text{s}$
$R_{th(s-a)}$	flow rate = 15 l/min, $T_{fluid}=40^{\circ}\text{C}$, water/glycol ratio 50%:50%				0.0087	K/W
$R_{CC'+EE'}$	measured per switch, $T_s = 25^{\circ}\text{C}$			0.09		$\text{m}\Omega$
L_{CE}	commutation inductance			6		nH
C_{CHC}	coupling capacitance secondary to heat sink			4.8		nF
C_{ps}	coupling capacitance primary to secondary			0.067		nF
$I_{CES} + I_{RD}$	$V_{GE} = 0\text{ V}$, $V_{CE} = 1700\text{ V}$, $T_j = 25^{\circ}\text{C}$			0.211		mA
M_{dc}	DC terminals		6		8	Nm
M_{ac}	AC terminals		13		15	Nm
w	SKiiP System w/o heat sink			2.48		kg
w_h	heat sink			3.49		kg

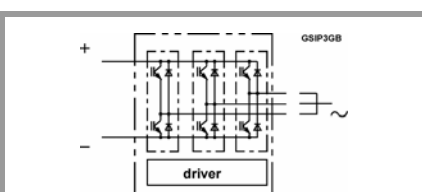

GB

Isolation coordination acc. to EN 50178 and IEC 61800-5-1

Maximum grid RMS voltage, line-to-line, grounded delta mains	690V+20%
Installation altitude for maximum grid RMS voltage, line-to-line, grounded delta mains	2000m
Maximum grid RMS voltage, line-to-line, star point grounded mains	690V+20%
Installation altitude for maximum grid RMS voltage, line-to-line, star point grounded mains	4000m
Maximum transient peak voltage between low voltage circuit and mains	1900V
Pollution degree acc. to IEC 60664-1 outside the moulded power section	2
Overvoltage cat. acc. to IEC 60664-1 for mains	III
Overvoltage cat. acc. to UL 840 within mains	I
Overvoltage cat. acc. to UL 840 between mains and ground	III
Overvoltage cat. acc. to UL 840 between mains and low voltage circuit	III
Basic isolation	between heat sink and mains
Reinforced isolation	between low voltage circuit and mains
Protection level acc. to IEC 60529	IP00

Environmental conditions acc. to IEC 60721

	Storage	Transportation	Operation stationary use at weather protected locations	Operating ground vehicle installations	Operating ship environment
Climatic conditions	1K2 ₍₁₎	2K2 ₍₁₎	3K3 ₍₁₎	5K1 ₍₁₎	6K1 ₍₁₎
Biological conditions	1B1	2B1	3B1	5B1	6B1
Chemically active substances (excluded: salt spray)	1C2	2C1	3C2	5C2	6C2
Mechanically active substances	1S1	2S1	3S1	5S1	6S1
Mechanical conditions	1M3	(4)	3M6 ₍₂₎	5M3 ₍₃₎	6M3
Contaminating fluids	---	---	---	5F1	---

(1) expanded temperature range: -40°C / +85°C. Please note: by operation near 85°C the life time of product is reduced.

(2) 3M7 possible, but due to the mechanic load capacity of external components like DC-Link capacitors limited to 3M6

(3) 5M3 without impact of foreign bodies, stones

(4) no declaration due to customer-specific packing

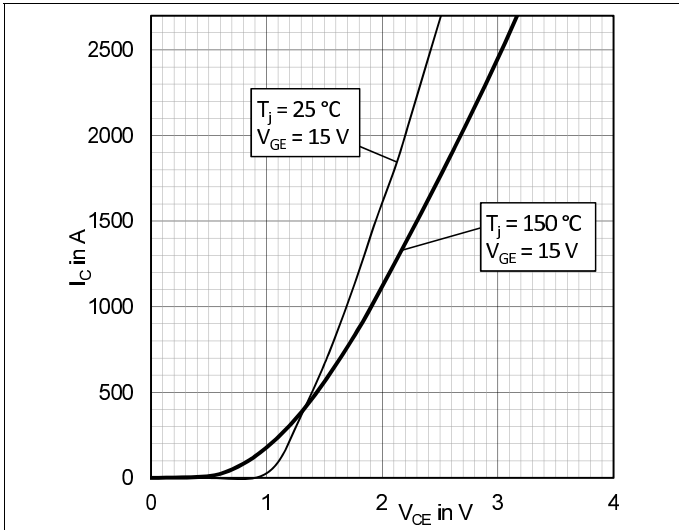

Fig. 1: Typical IGBT output characteristics

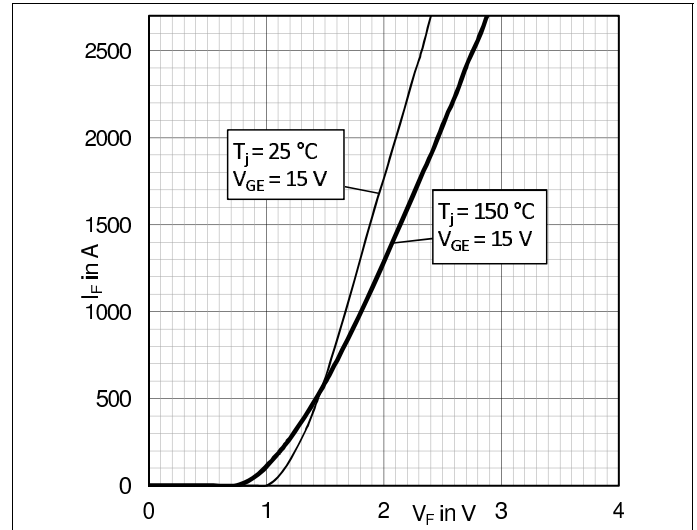

Fig. 2: Typical diode output characteristics

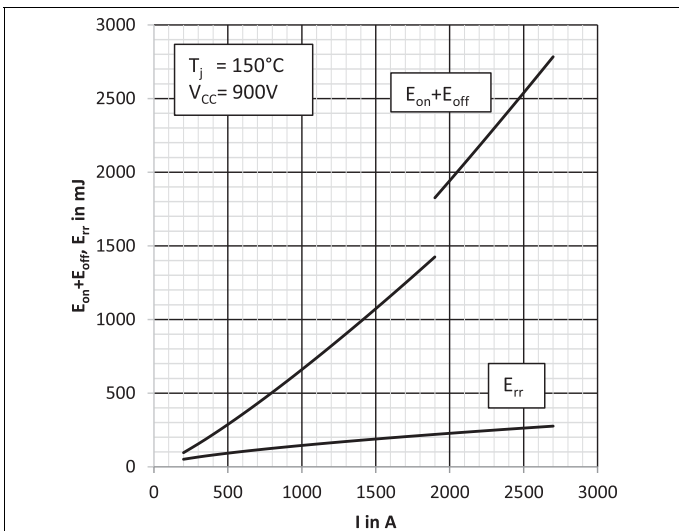

Fig. 3: Typical switching energy $E = f(I_C)$

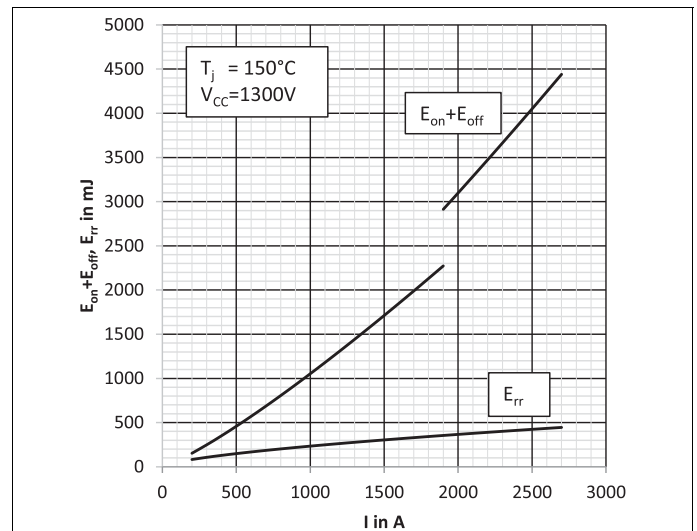

Fig. 4: Typical switching energy $E = f(I_C)$

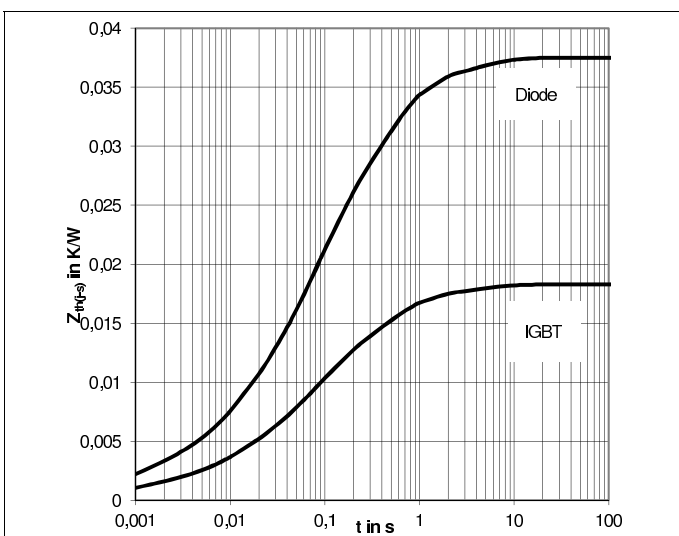

Fig. 5: Transient thermal impedance $Z_{th}(j-r)$

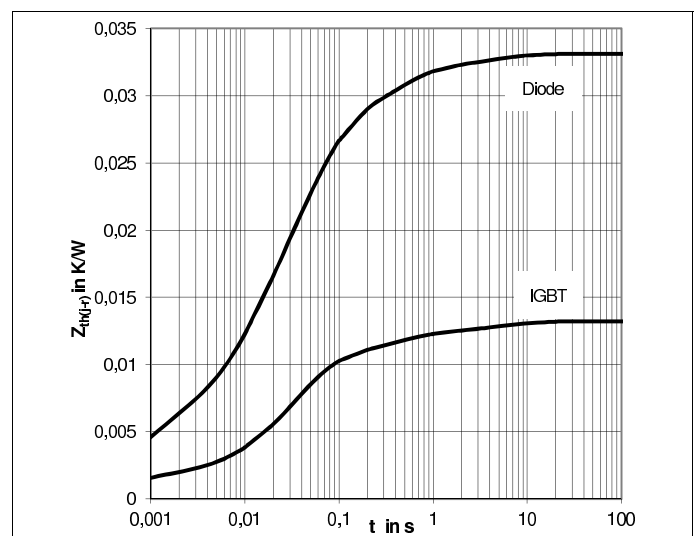

Fig. 6: Transient thermal impedance $Z_{th}(j-r)$

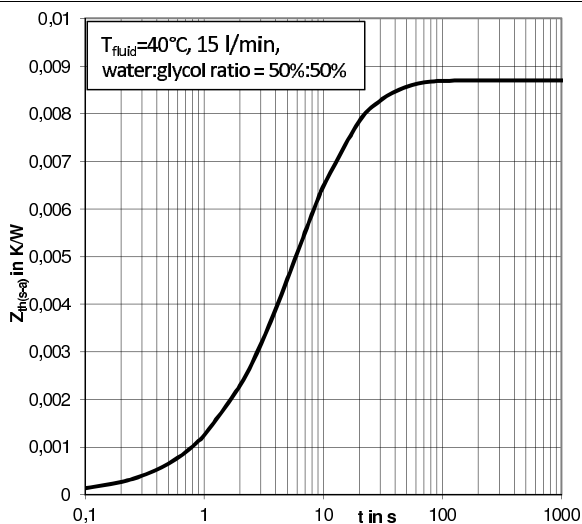

Fig. 7: Transient thermal impedance $Z_{th}(s-a)$

	$R_{th} [K/W]$				
	1	2	3	4	5
$Z_{th(j-s)} I$	0,0013	0,0065	0,0073	0,0022	0,0010
$Z_{th(j-s)} D$	0,0026	0,0134	0,0149	0,0045	0,0021
$Z_{th(j-r)} I$	0,0010	0,0020	0,0024	0,0063	0,0015
$Z_{th(j-r)} D$	0,0013	0,0047	0,0147	0,0077	0,0047
$Z_{th(s-a)}$	0,0022	0,0065			
	$\tau [s]$				
	1	2	3	4	5
$Z_{th(j-s)} I$	3,6500	0,4100	0,0650	0,0090	0,0008
$Z_{th(j-s)} D$	3,6500	0,4100	0,0650	0,0090	0,0008
$Z_{th(j-r)} I$	4,9063	0,3488	0,0425	0,0302	0,0005
$Z_{th(j-r)} D$	3,9144	0,3552	0,0455	0,0112	0,0007
$Z_{th(s-a)}$	17,9322	5,2720			

Fig. 8: Coefficients of thermal impedances

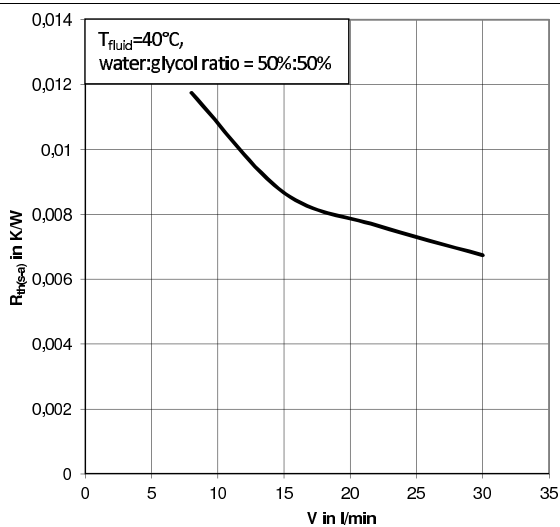

Fig. 9: Thermal resistance $R_{th}(s-a)$ versus flow rate V

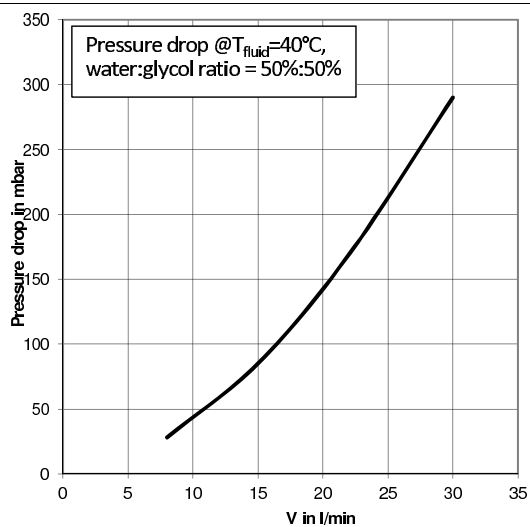
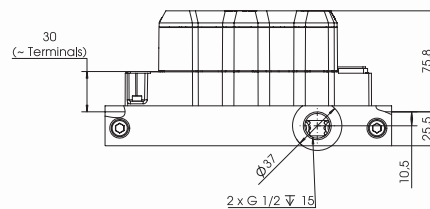
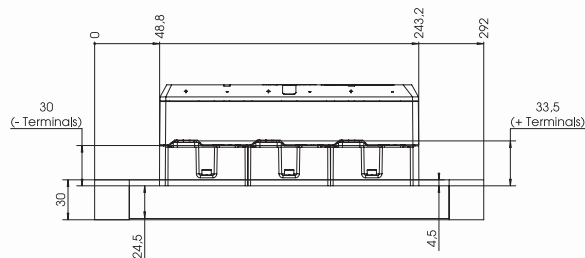
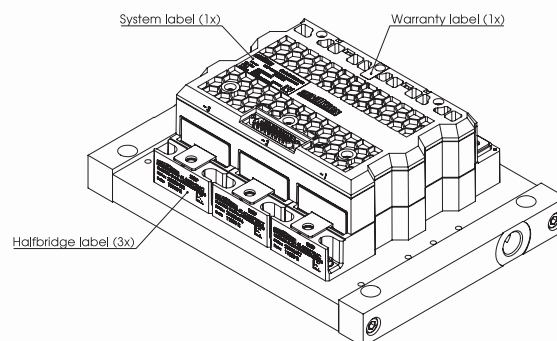
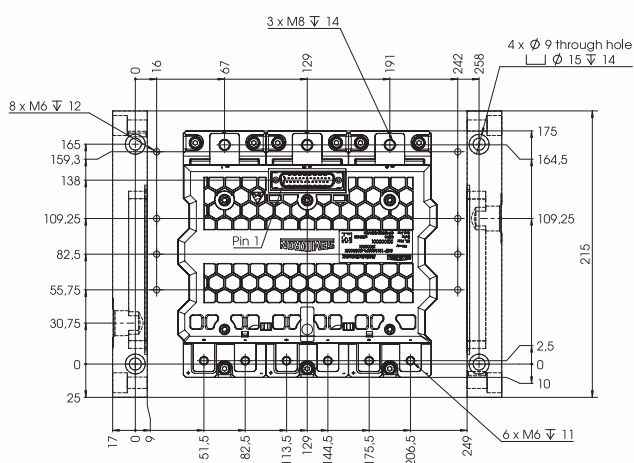

Fig. 10: Pressure drop Δp versus flow rate V

SKiP 1814 GB17E4-3DUW V2



All dimensions in mm!



Nominal pressure = 3 bar
 Test pressure = 6 bar for 10 min.
 Coolant with percentage of glycol $\geq 10\%$

System

This is an electrostatic discharge sensitive device (ESDS), international standard IEC 60747-1, chapter IX.

*IMPORTANT INFORMATION AND WARNINGS

The specifications of SEMIKRON products may not be considered as guarantee or assurance of product characteristics ("Beschaffenheitsgarantie"). The specifications of SEMIKRON products describe only the usual characteristics of products to be expected in typical applications, which may still vary depending on the specific application. Therefore, products must be tested for the respective application in advance. Application adjustments may be necessary. The user of SEMIKRON products is responsible for the safety of their applications embedding SEMIKRON products and must take adequate safety measures to prevent the applications from causing a physical injury, fire or other problem if any of SEMIKRON products become faulty. The user is responsible to make sure that the application design is compliant with all applicable laws, regulations, norms and standards. Except as otherwise explicitly approved by SEMIKRON in a written document signed by authorized representatives of SEMIKRON, SEMIKRON products may not be used in any applications where a failure of the product or any consequences of the use thereof can reasonably be expected to result in personal injury. No representation or warranty is given and no liability is assumed with respect to the accuracy, completeness and/or use of any information herein, including without limitation, warranties of non-infringement of intellectual property rights of any third party. SEMIKRON does not assume any liability arising out of the applications or use of any product; neither does it convey any license under its patent rights, copyrights, trade secrets or other intellectual property rights, nor the rights of others. SEMIKRON makes no representation or warranty of non-infringement or alleged non-infringement of intellectual property rights of any third party which may arise from applications. Due to technical requirements our products may contain dangerous substances. For information on the types in question please contact the nearest SEMIKRON sales office. This document supersedes and replaces all information previously supplied and may be superseded by updates. SEMIKRON reserves the right to make changes.