

PHASE CONTROL THYRISTOR

AT681

Repetitive voltage up to **6000 V**
Mean forward current **840 A**
Surge current **10 kA**

FINAL SPECIFICATION

Feb. 17 - Issue: 4

Symbol	Characteristic	Conditions	T _j [°C]	Value	Unit
BLOCKING					
V _{RRM}	Repetitive peak reverse voltage		120	6000	V
V _{RSM}	Non-repetitive peak reverse voltage		120	6100	V
V _{DRM}	Repetitive peak off-state voltage		120	6000	V
I _{RRM}	Repetitive peak reverse current	V=VRRM	120	150	mA
I _{DRM}	Repetitive peak off-state current	V=VDRM	120	150	mA
CONDUCTING					
I _{T(AV)}	Mean forward current	180° sin, 50 Hz, Th=55°C, double side cooled		840	A
I _{T(AV)}	Mean forward current	180° sin, 50 Hz, Tc=85°C, double side cooled		706	A
I _{TSM}	Surge forward current	Sine wave, 10 ms	120	10	kA
I ² t	I ² t	without reverse voltage		500 x 10 ³	A ² s
V _T	On-state voltage	On-state current = 1570 A	25	2,40	V
V _{T(TO)}	Threshold voltage		120	1,30	V
r _T	On-state slope resistance		120	1,150	mohm
SWITCHING					
di/dt	Critical rate of rise of on-state current, min.	From 75% VDRM up to 1200 A; gate 10V, 5Ω	120	100	A/μs
dv/dt	Critical rate of rise of off-state voltage, min.	Linear ramp up to 75% of VDRM	120	500	V/μs
t _d	Gate controlled delay time, typical	VD=200V; gate source 20V, 10Ω, tr=.5 μs	25	5,0	μs
t _q	Circuit commutated turn-off time, typical	dv/dt = 20 V/μs linear up to 80% VDRM		650	μs
Q _{rr}	Reverse recovery charge	di/dt = -20 A/μs, I= 1000 A	120		μC
I _{rr}	Peak reverse recovery current	VR= 50 V			A
I _H	Holding current, typical	VD=5V, gate open circuit	25	300	mA
I _L	Latching current, typical	VD=5V, tp=30μs	25	700	mA
GATE					
V _{GT}	Gate trigger voltage	VD=5V	25	3,50	V
I _{GT}	Gate trigger current	VD=5V	25	400	mA
V _{GD}	Non-trigger gate voltage, min.	VD=0,5VDRM	120	0,50	V
V _{FGM}	Peak gate voltage (forward)			30	V
I _{FGM}	Peak gate current			10	A
V _{RGM}	Peak gate voltage (reverse)			5	V
P _{GM}	Peak gate power dissipation	Pulse width 100 μs		150	W
P _G	Average gate power dissipation			2	W
MOUNTING					
R _{th(j-h)}	Thermal impedance, DC	Junction to heatsink, double side cooled		21,0	°C/kW
R _{th(c-h)}	Thermal impedance	Case to heatsink, double side cooled		6,0	°C/kW
T _j	Operating junction temperature			-30 / 120	°C
F	Mounting force			22,0 / 24,5	kN
	Mass			520	g

ORDERING INFORMATION : AT681 S 60

standard specification VRRM/100

DISSIPATION CHARACTERISTICS

SQUARE WAVE

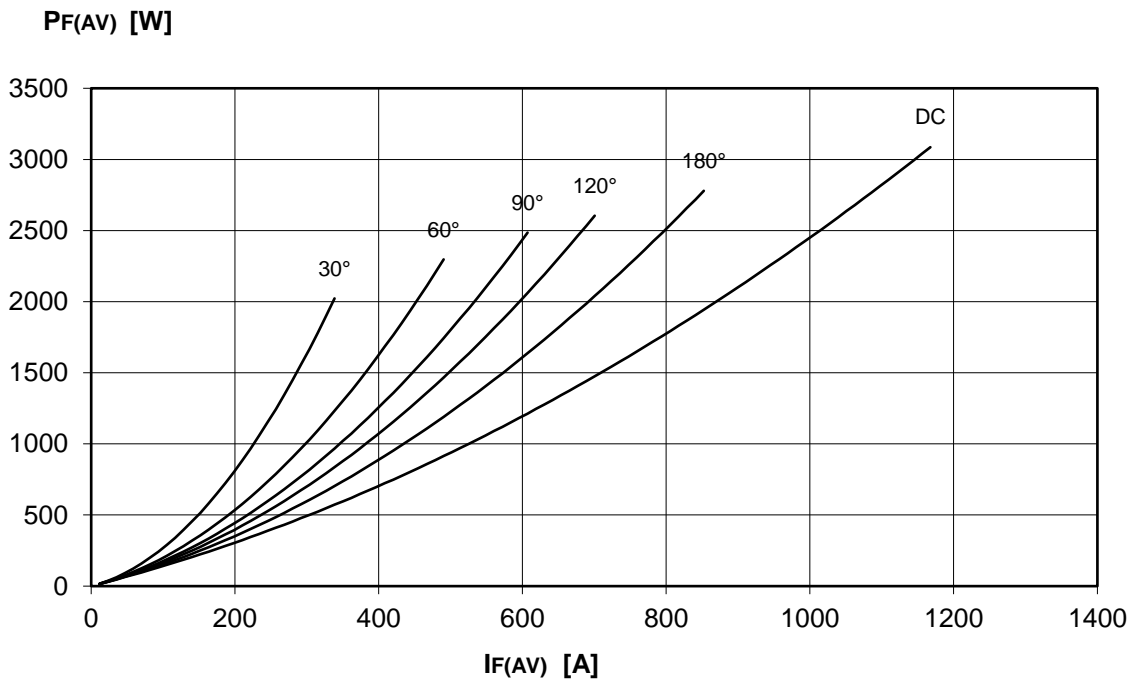
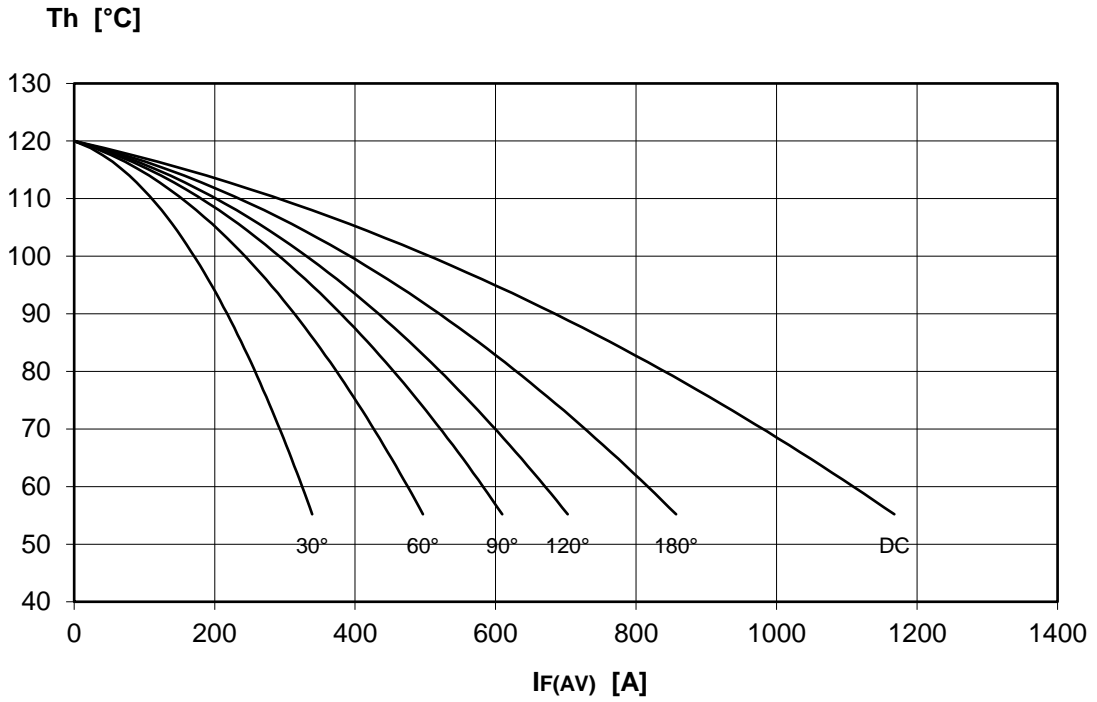

DISSIPATION CHARACTERISTICS

SINE WAVE

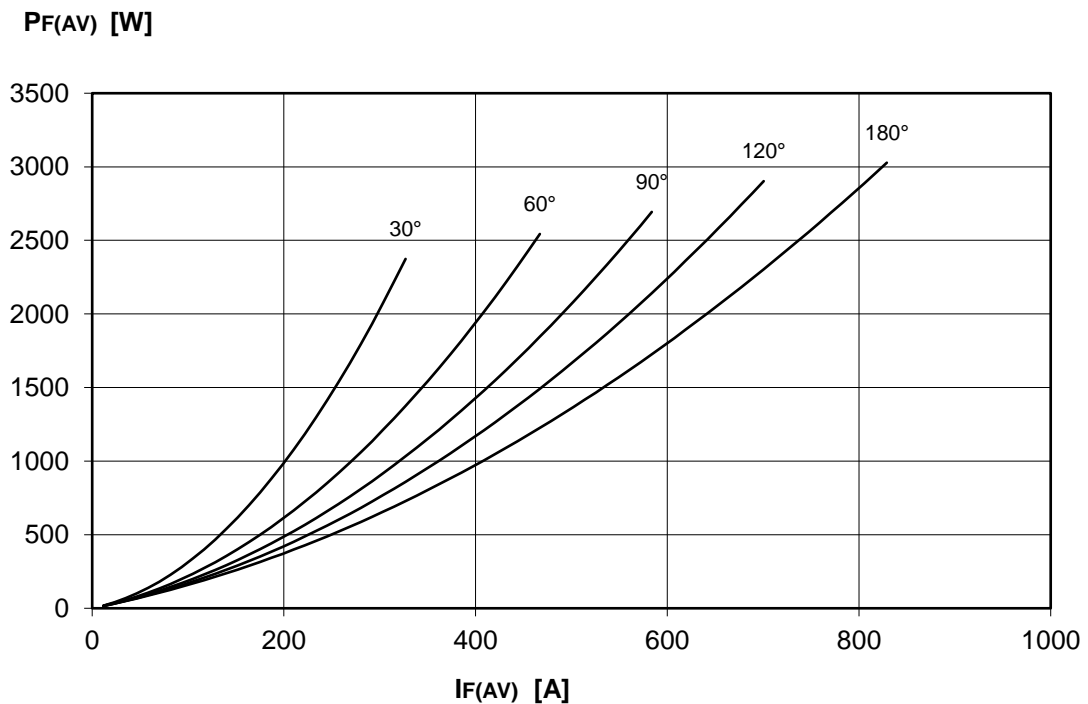
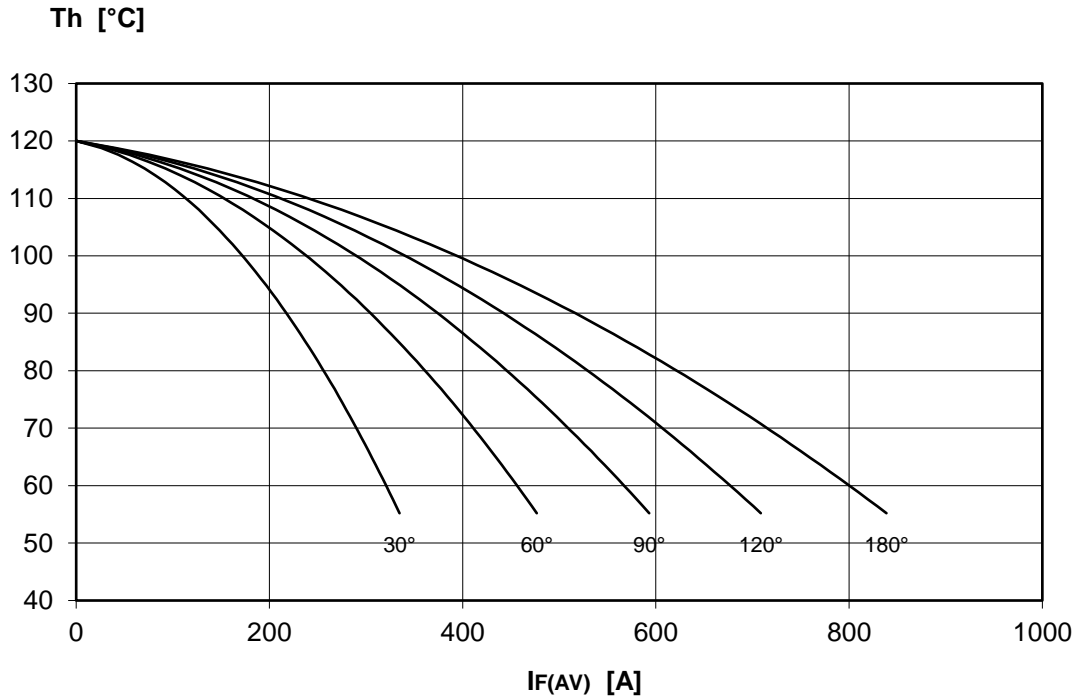

AT681 PHASE CONTROL THYRISTOR



FINAL SPECIFICATION Feb. 17 - Issue: 4

ON-STATE CHARACTERISTIC
T_j = 120 °C

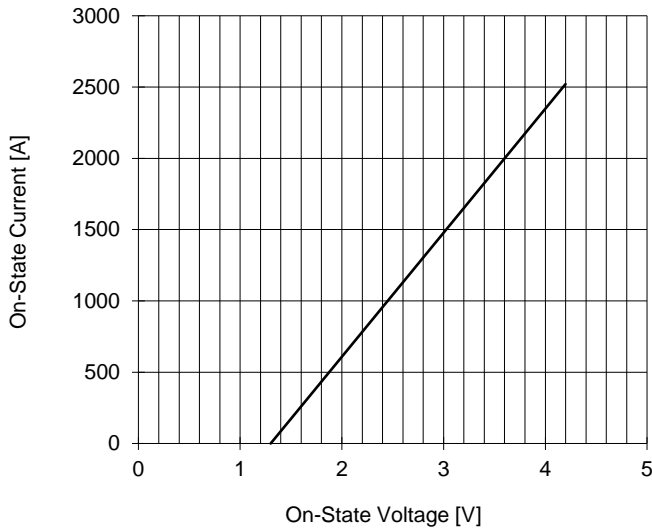

SURGE CHARACTERISTIC
T_j = 120 °C

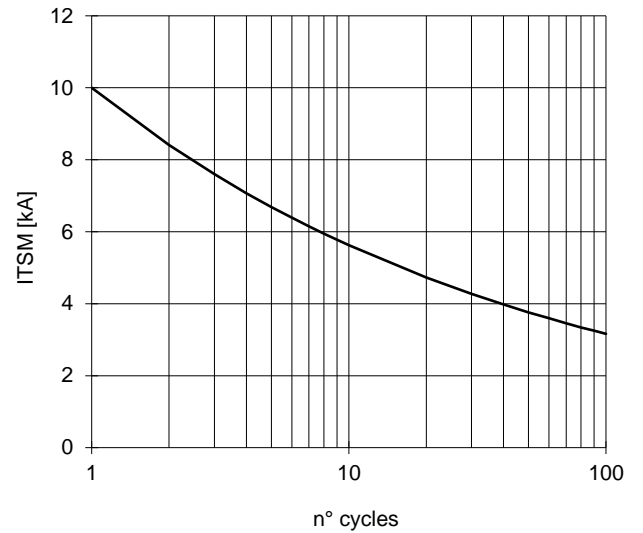

TRANSIENT THERMAL IMPEDANCE
DOUBLE SIDE COOLED

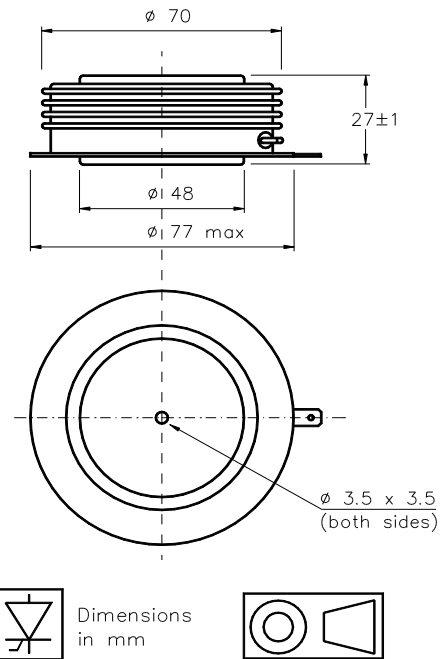
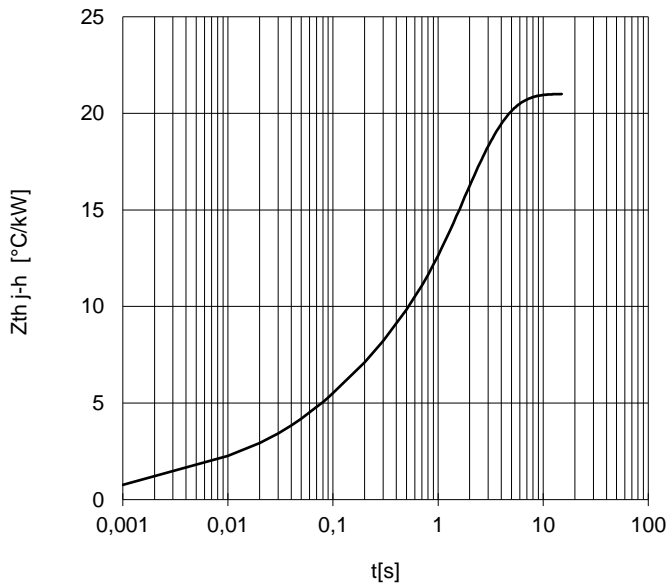

Cathode terminal type DIN 46244 - A 4.8 - 0.8

Gate terminal type AMP 60598 - 1

Distributed by

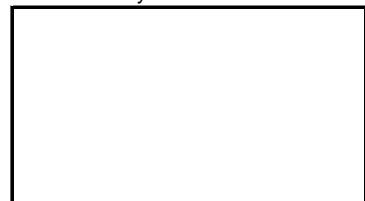

All the characteristics given in this data sheet are guaranteed only with uniform clamping force, cleaned and lubricated heatsink, surfaces with flatness < .03 mm and roughness < 2 μm. In the interest of product improvement POSEICO SpA reserves the right to change any data given in this data sheet at any time without previous notice. If not stated otherwise the maximum value of ratings (symbols over shaded background) and characteristics is reported.